



SENSOR-DRIVEN MOTOR CONTROLLER (WIND/ LIGHT)

SMS 1 (rail mounting version)

SMS U1 (flush mounting version)

COMBINATION WIND/LIGHT SENSOR SWL 2

Compact, easily installed awning controller with integrated wind and light sensing. Automatic shading control and protection against awning damage from high wind speed.

Special features

- ▶ Comfort and security control
- ▶ Integrated sensor power source (PELV); no external power supply necessary
- ▶ Can also be used as a group controller for lower-level roller shutter or louver blind controllers
- ▶ Combined wind and light sensor
- ▶ Low power consumption
- ▶ SMS 1 features:
 - Choice of SWL 2 combination sensor or separate SW 2 and SL 1 sensors
 - Additional automatic twilight function
 - Floating relay contacts

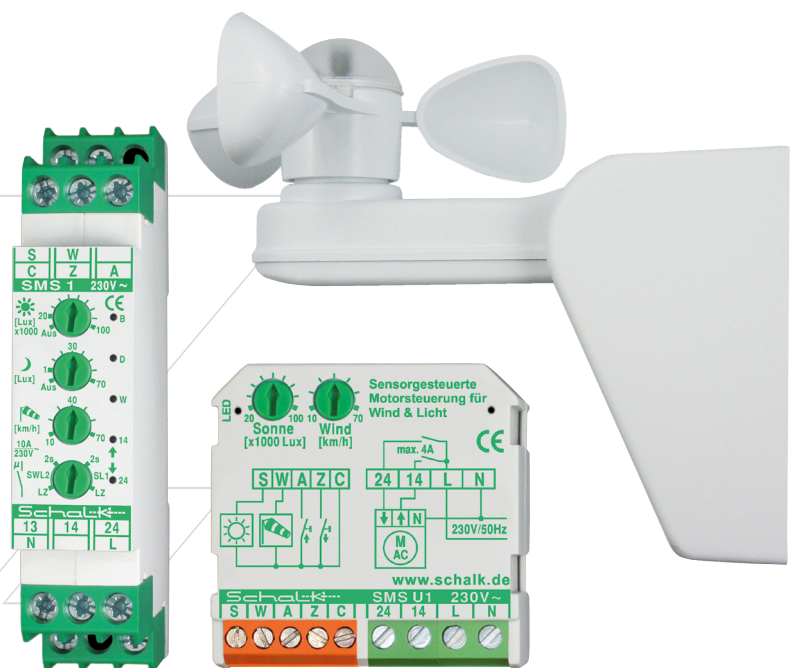

General information

The SMS 1 or SMS U1 is used with the SWL 2 combined wind and light sensor for reliable and convenient control of awnings or external louver blinds.

The awning is automatically extended under bright sunlight conditions and retracted when brightness decreases.

The awning is automatically retracted under high wind conditions.

The SMS 1 additionally has an integrated twilight function and supports a choice of sensors.

Push-buttons for direct open/close operation can be connected. The automatic twilight function can be disabled for a specific interval by a long button press.

Wind monitoring always takes priority to provide reliable protection against user errors.

Applications

Convenient automatic shading control with additional protection against wind damage to electrically operated awnings.

SMS 1 has an additional automatic twilight function for night-time room darkening.

Operation

The desired trigger thresholds are set by configuring the Sun and Wind settings (and Twilight with the SMS 1). The connected light sensor type can also be selected with the SMS 1. Relay outputs can also be configured separately for pulse output (2 s) or continuous output for the duration of the set motor run time (LZ).

When a set limit value is exceeded, the indicator LED starts to blink and the awning is actuated at the end of the response time. See the functional diagrams for details of the individual operation modes.

The awning can also be operated manually by a directly connected dual push-button (without mutual interlock). The response time of the automatic shading function is reset after each manual operation.

To manually compel a longer stable awning state, the automatic sunlight function can be completely disabled for 5 hours by pressing the Open or Close button for 5 seconds. Pressing a button during this period re-enables the automatic sunlight function.

The automatic wind function is always enabled and always overrides all other functions. This avoids the risk of damage to the awning system from strong wind, even in the event of accidental user error.

The response time for wind is preset and amounts to 1 to 15 seconds, depending on how much the wind speed exceeds the threshold value. The response time for sun exposure can be individually adjusted using a simple programming process (factory default setting: 10 minutes).

The motor run time can also be programmed to match the individual awning (factory default setting: 90 seconds). When the SMS 1 or SMS U1 is used as a group controller, this can also be set in a programming process. In this case the controller freezes the outputs until the wind level drops below the set limit value.

Controls and indicators

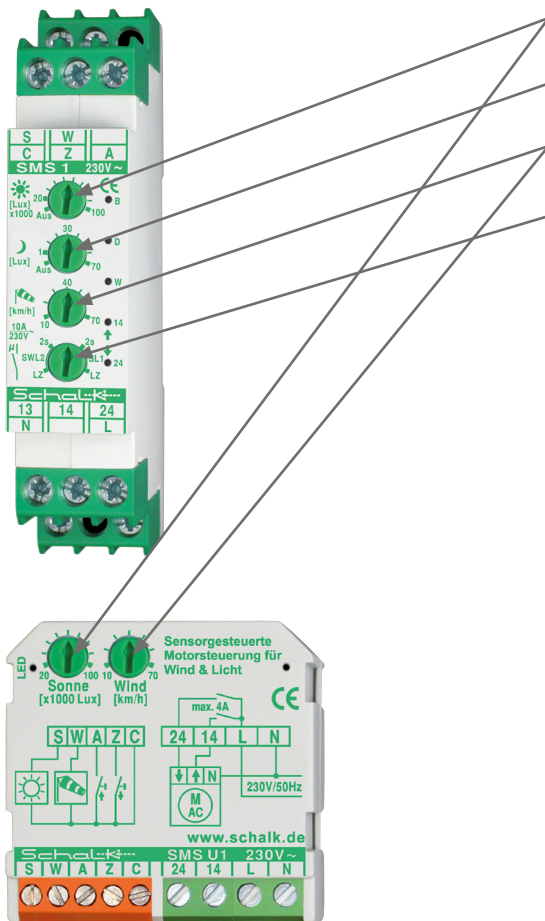

Light intensity threshold setting

Setting range 20,000 -100,000 lx

Twilight threshold setting (SMS 1 only)

Setting range 1 - 70 lx

Wind speed threshold setting

Setting range 10 - 70 km/h

Sensor type setting (SMS 1 only)

SWL 2 = combined wind and light sensor

SL 1 = light sensor

SW 2 = wind sensor (anemometer)

In the "2s" position the SMS 1 generates a 2-second control pulse on the relay output, which for example can be used to actuate lower-level controllers.

In the "Hold" position the programmed motor run times (see functional diagrams) apply.

Status indicator LEDs:

SMS U1: A blinking red LED (⊕) indicates wind speed above the threshold level; blinking green (⊕) indicates brightness above the threshold level.

SMS 1: Blinking red (⊕) with LED W indicates wind speed above the threshold level, with LED B light level above the brightness threshold, and with LED D light level below the twilight threshold.

LEDs 14 and 24 indicate the corresponding motion direction.

Status indicator LEDs

- LED off
- LED lit red
- ⊕ LED blinks red
- LED lit green
- ⊕ LED blinks green
- ⊕ LED blinks alternating red/green

Installation

Typical SMS U1 connection diagram:

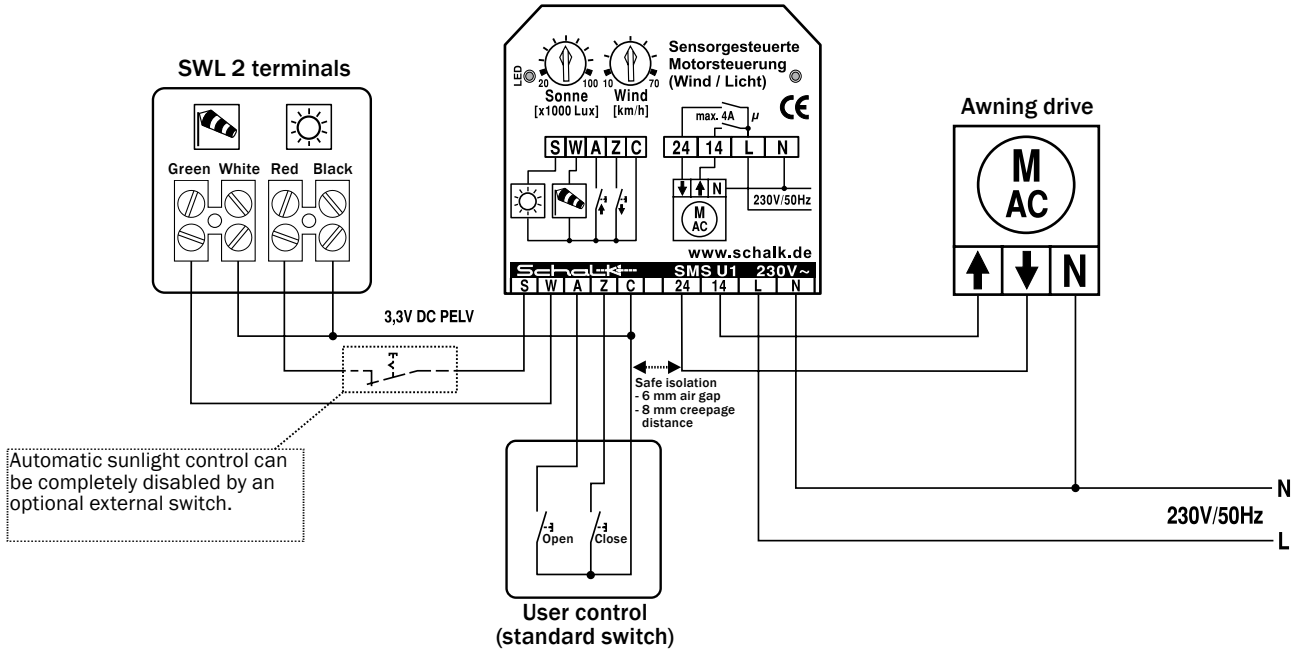

Typical SMS 1 connection diagram:

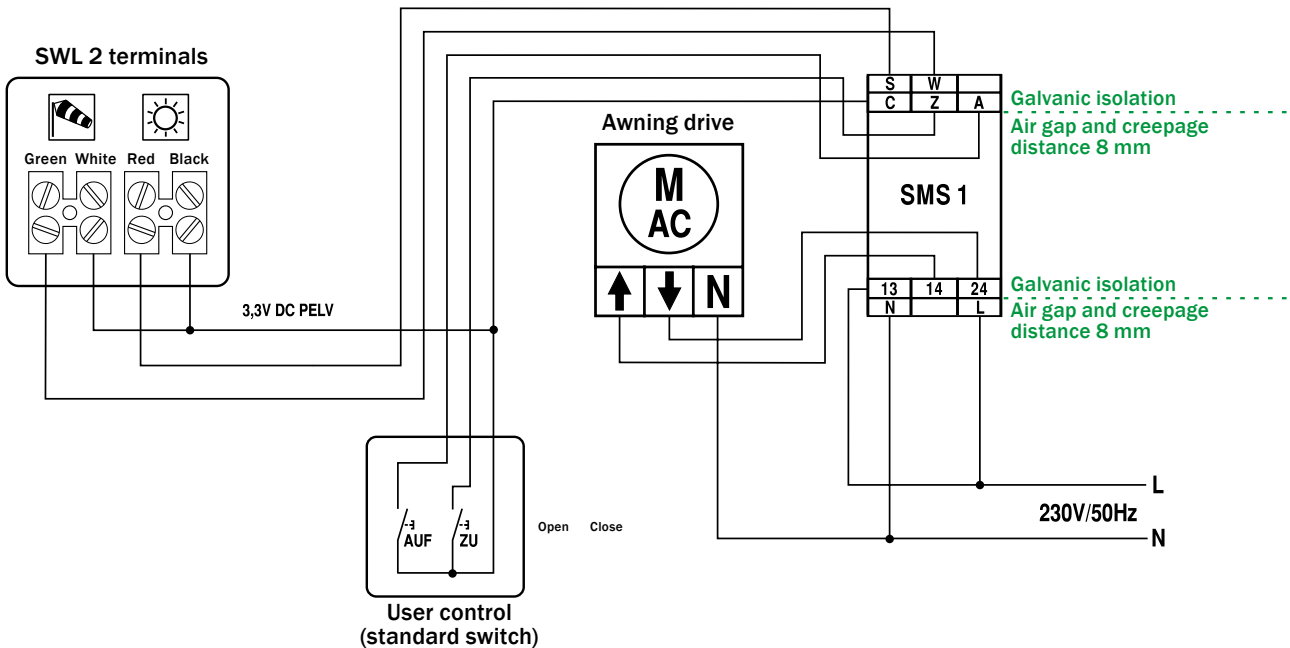

Attention!

Note: Incorrect connection of the SWL 2 sensor can cause faulty awning operation.

Configuration and commissioning

First configure the threshold values and sensor type (SMS 1) using the corresponding controls (see “Controls and indicators”). The following settings only have to be configured if the factory default settings are not suitable (see “Factory default settings”).

Attention!

Note: The awning must be in the home position (fully retracted) for this.

1) Press and hold the Open and Close inputs at the same time **for 10 seconds**

This activates programming mode with the three-step programming process.

Step 1: Adjust the response time for shading (and for twilight with SMS 1)

(SMS U1: LED lit green / SMS 1: LEDs B and D lit red)

The factory default response time is 10 minutes. This can be increased incrementally by pressing the Open button or decreased incrementally by pressing the Close button. To skip this setting, go directly to Step 2.

One button press corresponds to 1 minute response time

(Setting range: 1–60 min)

2) Briefly press the Open and Close buttons at the same time

This takes you to the second programming step and saves any previous settings you have made.

Step 2: Adjust the motor run time

(SMS U1: LED lit red / SMS 1: LED W lit red)

The factory default motor run time is 90 seconds. If the awning should only be extended to a specific position in automatic mode, all you have to do here is to extend it to this position by pressing the Open or Close buttons. To skip this setting, go directly to Step 3.

(Setting range: 1–240 s)

3) Briefly press the Open and Close buttons at the same time

This takes you to the third programming step and saves any previous settings you have made.

Step 3: Enable or disable group mode

(SMS U1: LED lit red-green / SMS 1: LEDs B, D and W lit red)

Group mode is disabled by default (factory setting). Press the Open button to enable group mode, or press the Close button to disable group mode.

4) Briefly press the Open and Close buttons at the same time

This exits programming mode and saves any previous settings you have made.

Factory default settings

The following default values are configured in the factory:

- Response time for sun exposure: 10 min
- Motor run time: 90 s

Restoring factory default settings:

If the controller is accidentally misconfigured, this can be corrected by restoring the factory default settings.

To do this, press the **Open** and **Close** buttons at the same time **for 20 seconds** until the LED blinks green and red (on the SMS 1, all LEDs will blink).

Info

After 30 seconds in setting mode with no button press, setting mode is exited automatically and all settings made up to that point are accepted.

- ▶ Terminal 14 retracts or raises the awning (Open button)
- ▶ Terminal 24 extends or lowers the awning (Close button)

Functional diagrams

The local Open and Close inputs are edge-triggered and respond to the falling edge of the signal:

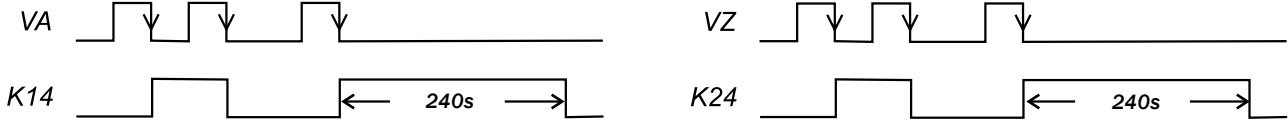

When the wind speed (frequency of the wind sensor pulse signal W) rises above the set threshold level, the local Open and Close inputs are completely blocked. The light sensor also has no effect on the controller under this condition. The inputs are enabled again after the wind speed drops below the set threshold level:

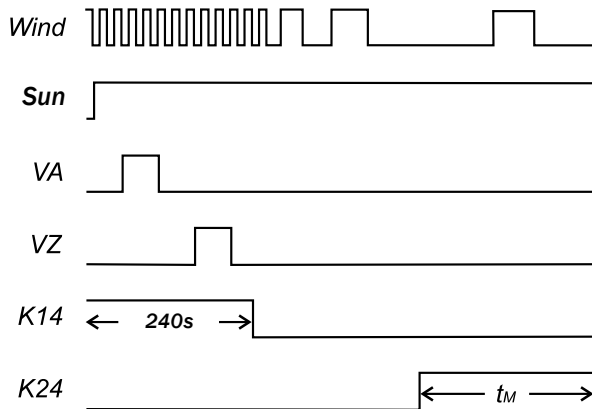

To protect the awning motor, there is a dead time t_{uv} of 0.6 second for switching between K14 and K24:

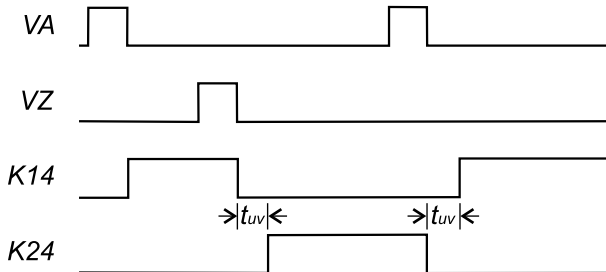

If you wish to disable the automatic shading function, simply press and hold one of the control buttons for 5 seconds. This will fully disable the automatic sunlight function for 5 hours. It is enabled again at the end of this period, or earlier if the awning is moved.

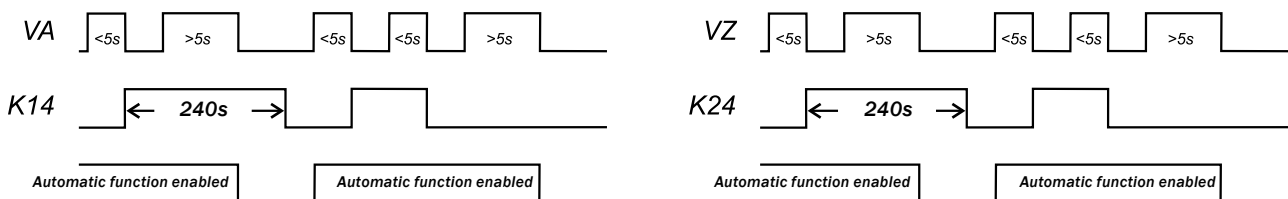

Legend:

- t_M Motor run time (user programmable)
- t_{uv} Switching dead time
- VA Local input for "Open" push-button
- VZ Local input for "Close" push-button
- K14 Terminal 14 on SMS 1 or SMS U1
- K24 Terminal 24 on SMS 1 or SMS U1
- W Wind sensor
- S Light sensor

SMS 1 / SMS U1 technical data

Operating voltage	230 V 50/60Hz 10 %
Power consumption	approx. 0.66 W
Wind measuring range	10-70 km/h
Wind switching hysteresis	25 %
Wind response time	1s - 15s
Sun measuring range	Light intensity: 20000Lux - 100000Lux / Twilight: 1Lux - 70Lux
Sun switching hysteresis	Light intensity: 40 % / Twilight: 20%
Sun response time	10 min (user programmable)
Motor run time	90s (user programmable)
Relay switching dead time	0.6s
Sensor supply voltage	3.3 V DC (PELV)
Ambient temperature	-10°C to +45°C
Noise immunity	Compliant with IEC 0801-4 Level 3
Device protection	Compliant with IEC 0801-5 Level 3
Creepage distance and air gap	Compliant with VDE 0110 Gr. C/250 V
Insulating housing	Non-flammable VDE 0304 Part 3, Level FV 0
Installation orientation	Any
RAL colour	Grey 7035 / Green 6029

SMS U1:

Relay output	2 NO contacts 4 A / 250 V AC
AC terminals	Female terminals with captive screws M3.0 (2x 1.5 mm ² / 1x 2.5 mm ²)
PELV terminals	Female terminals with captive screws M2 (1x 1.5 mm ²)
Dimensions	43 x 43 x 18.5mm ³

SMS 1:

Relay output	2 floating NO contacts 10 A / 250 V AC
Mounting	Snap mount on standard 35-mm rail (EN 50022)
Terminals	Female terminals with captive screws M3.5 (2x 1.5 mm ² / 1x 2.5 mm ²)
Dimensions	18 x 88(45) x 58mm ³

SWL 2 technical data

Wind sensor	Reed contact pulse transducer
Light sensor	LDR
Connecting cable	max. 50m (with 2 x 0.25 mm ²)
Dimensions	ca. 60 x 80 x 180mm ³
Protection rating	IP33
Colour	White

Order data

Part no.	EAN	Type	Designation
SMSU19	4 046929 401111	SMS U1	Sensor-driven motor controller (wind/light), 230V AC (UP)
SMS109	4 046929 401135	SMS 1	Sensor-driven motor controller (wind/light), 230V AC (REB)
SWL200	4 046929 301282	SWL 2	Combined wind/light sensor with articulated mount